

Metal Storage Furniture > Price Book > USA > March 2017



OFFICE FURNITURE SOLUTIONS

TABLE OF CONTENTS

AVAILABLE SPECIALS	2	OPTION SPECIFICATIONS AND FINISHES	9
QUICKSHIP PROGRAM	2	METAL STORAGE FURNITURE	
SPECIFICATIONS	3	LATERAL FILES	10
CHOOSING THE RIGHT STORAGE FURNITURE	3	CABINETS	11
HEIGHT COMPARISON	4	BOOKCASES	11
CAPACITY AND FILING SPACE	4	WARDROBES	11
COUNTERWEIGHTS AND ANCHORS	5	MULTIFUNCTION STORAGE FURNITURE	12-13
LOCKING PROGRAM	5	VERTICAL FILES	13
LATERAL FILES / CABINETS AND BOOKCASES	6	LAMINATE TOPS	13
WARDROBES / MULTIFUNCTION STORAGE FURNITURE	7-8	ACCESSORIES	14
VERTICAL FILES	8	TERMS AND CONDITIONS OF SALE	15

FIND OUT ABOUT OUR AVAILABLE SPECIALS!

Other special products are also available upon request: lockers, plan files, display cases, filing bookcases, etc. For information purposes, here are some examples of special products:

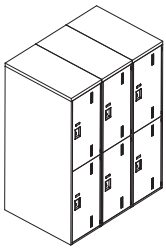

Customized locker

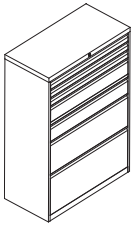

Multidrawer lateral file

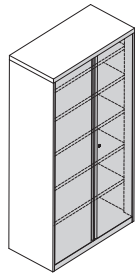

2-tone cabinet
72" H (1829 mm)

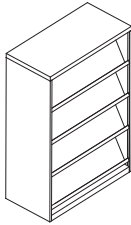

Display case

CUSTOMIZED COLORS:

- It is possible to get a two-tone layout by specifying the front and case colors.
- It is also possible to develop a storage unit with your choice of color.

CUSTOMIZED DRAWERS DIMENSIONS AND CONFIGURATIONS:

- Standard-sized cases can easily accommodate your choice of drawer heights: 3" (76 mm), 6" (152 mm), 9" (229 mm), 12" (305 mm), 13 1/2" (343 mm) and 15" (381 mm).
- A storage unit can also be made with special dimensions (W x H x D).

IMPORTANT:

No minimum quantity necessary. However, certain conditions, dimensional limitations and development costs may apply. For any special request, please send your request to special@groupe-lacasse.com. For further information, please contact the Groupe Lacasse Customer Service.

READY TO SHIP IN 5 DAYS!

Several components and accessories identified by this pictogram are part of the **Lacasse QuickShip** program.



PROGRAM CONDITIONS AND LIMITATIONS:

- Maximum of **five (5)** of each item and each color per order.
- Products are ready for shipment **5 business days** after reception of a ready-to-process order and delivered on next available trailer.

IMPORTANT:

Place QuickShip orders separately from regular Lacasse orders. When preparing QuickShip orders, indicate the code "QS" in front of the QuickShip product code; i.e.: QSRIDFS-183628LF2.

SPECIFICATIONS

CHOOSING THE RIGHT STORAGE FURNITURE

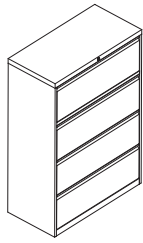

Lateral file with fixed fronts

Offers a superior filing capacity. Perfect for any workstation; allowing an easy access to files.

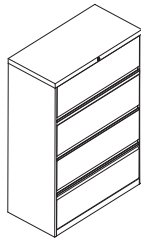

Lateral file with receding fronts and roll-out shelves

Designed for a quick consultation of documents with end-tabs. Perfect for the medical field.

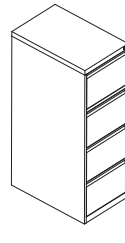

Vertical file

Offers storage that takes up little floor space. Perfect for long-term filing.

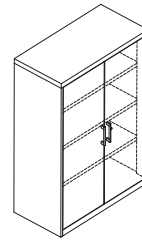

Cabinet / bookcase

Adjustable shelves allow an optimal use of storage space. Perfect for binders, books, catalogues and stationery.

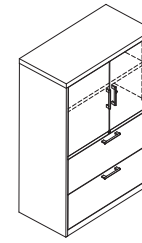

Multifunction storage unit

The different compartments offer diversified storage space. Perfect for a small volume of filing and for an individual workstation.

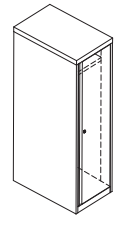

Wardrobe

Offers a safe personal storage space for clothes, shoes, bags, etc.

General Information

- In this price book, dimensions are exact and may differ from other Groupe Lacasse collections.
- Metal storage furniture is GREENGUARD GOLD certified and meets or exceeds ANSI/BIFMA standards. See product specifications for more details.
- Products are made from 68% recycled materials and are 99.5% recyclable.
- Metal storage furniture is shipped assembled and ready to use.
- Cleaning method: clean furniture with a damp cloth and mild soap. Dry the surface with a soft cloth.

Design

- All products in this collection were carefully designed with horizontal lines that maintain a uniform appearance among the different storage units.
- Inset drawers and doors create a sleek and neutral look.

- The case construction with smooth seams and no overlaps allows to place the storage units side by side without creating unwanted gaps.
- The storage furniture gets its impeccable look from a smooth-finish powder paint.

General Specifications

- Each unit is equipped with 4 levelers that are accessible from the inside and allow an adjustment of 1" (25 mm), ensuring stability on uneven floors.
- The inside of storage units and drawers are the same color as the outside.
- Storage units with a height of 27 7/8" (708 mm) can support a work surface with a conventional height of 29" (737 mm) or more.
- Adding a laminate top on a unit that has a height of 27 7/8" (708 mm) or 40 1/16" (1018 mm) creates a work space at sitting or standing heights. See page 13.
- Classic (Z) and Straight (K) pulls are interchangeable; 5" (128 mm) on center drillings.

Steel Gauges

Storage furniture is entirely made and welded with first-quality cold-rolled steel. Please note that the lower the gauge, the thicker the steel.

	Lateral files / Multifunction files / Low storage units	Vertical files	Cabinets / Wardrobes	Bookcases	Cabinets-Lateral files combos
Top	20	20	20	20	20
Side	20	20	20	20	20
Back	20	20	20	20	20
Bottom	20	16	16	16	20
Drawer front	20	20	-	-	20
Drawer side	18	20	-	-	18
Drawer bottom	20	20	-	-	20
Top reinforcement	18	18	-	-	18
Side reinforcement	18	18	-	-	18
Crossbar	20*	20	-	-	20
Leveler support	16	-	-	-	16
Flip system	20*	-	-	-	-
Door	-	-	20	-	20
Shelf	-	-	22	22	22
Shelf support	-	-	18 / -	18	18

* If applicable.

SPECIFICATIONS

HEIGHT COMPARISON VERSUS NVISION PANEL-BASED SYSTEM

The furniture presented in this list was designed to optimize filing and storage capacity. For that reason, heights are not the same as those of Nvision panels. For aesthetic reasons, it is recommended to specify a storage unit lower than the panel. The following image shows the different possibilities.

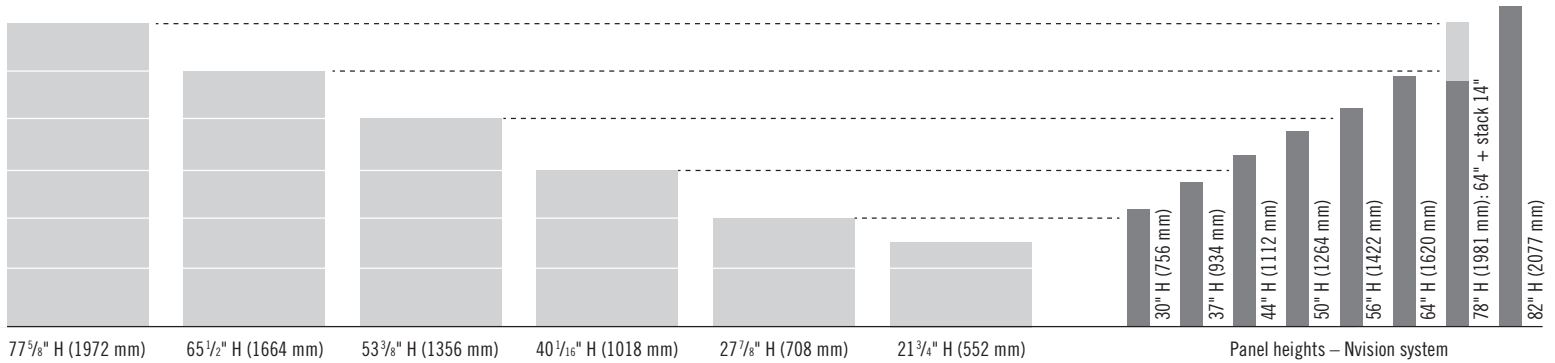

Note: Heights shown with levelers at minimum position. Storage furniture allows a 1" (25 mm) adjustment. Nvision panels allow a 1 1/2" (38 mm) adjustment of levelers.

LATERAL FILES CAPACITY AND FILING SPACE

Fixed front Drawers	W x D x H (in)	W x D x H (mm)	Capacity	Filing Space - Letter Size		Filing Space - Legal Size	
				Left / Right	Front / Rear*	Left / Right	Front / Rear*
30" W (762 mm)	26 3/4 x 15 1/16 x 11 5/8	679 x 383 x 295	90 lb / 40.8 kg				
				26 3/4" (679 mm)	30 1/8" (765 mm)	26 3/4" (679 mm)	15 1/16" (383 mm)
36" W (914 mm)	32 3/4 x 15 1/16 x 11 5/8	832 x 383 x 295	105 lb / 47.6 kg				
				32 3/4" (832 mm)	30 1/8" (765 mm)	32 3/4" (832 mm)	30 1/8" (765 mm)
42" W (1067 mm)	38 3/4 x 15 1/16 x 11 5/8	984 x 383 x 295	125 lb / 56.7 kg				
				38 3/4" (984 mm)	45 3/16" (1148 mm)	38 3/4" (984 mm)	30 1/8" (765 mm)

* Requires front-to-back hanging bars, sold separately. See page 14.

Note: Fixed and roll-out shelves have an interior height of 10 5/8" (270 mm) instead of 11 5/8" (295 mm) to allow the receding front to operate.

CABINETS AND BOOKCASES CAPACITY AND FILING SPACE

Shelves	Interior Dimensions				Capacity (weight uniformly distributed)	
	Cabinet		Bookcase		Cabinet	Bookcase
	W x D x H (in)	W x D x H (mm)	W x D x H (in)	W x D x H (mm)		
30" W (762 mm)	29 3/4 x 14 1/4 x 3/4	756 x 362 x 19	29 3/4 x 16 3/4 x 3/4	756 x 425 x 19	90 lb / 40.8 kg	105 lb / 47.6 kg
36" W (914 mm)	35 3/4 x 14 1/4 x 3/4	908 x 362 x 19	35 3/4 x 16 3/4 x 3/4	908 x 425 x 19	105 lb / 47.6 kg	125 lb / 56.7 kg
42" W (1067 mm)	41 3/4 x 14 1/4 x 3/4	1060 x 362 x 19	41 3/4 x 16 3/4 x 3/4	1060 x 425 x 19	125 lb / 56.7 kg	145 lb / 65.8 kg

COUNTERWEIGHTS AND ANCHORS

The products of this collection are delivered without counterweights or ganging hardware. In order to meet ANSI/BIFMA standards of stability, some products must be installed under a work surface, be ganged/anchored or have a counterweight. Please see each product's Specifications section for more details.

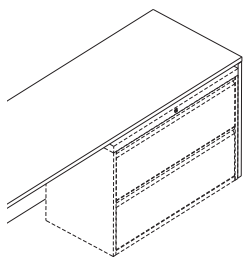

Installation under
a work surface

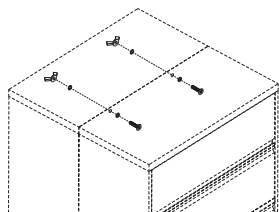

Back-to-back or side-by-side ganging*

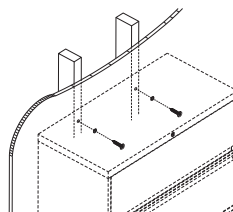

Wall anchoring

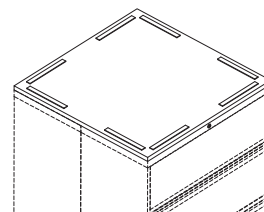

Ganging with a laminate top

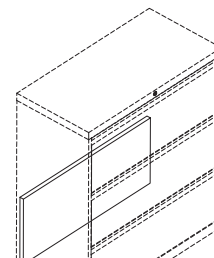

Factory-installed
counterweight**

* Ganging kit **RINNN-GKIT** sold separately, page 14.

** Refer to the price book to find out applicable fees.

LOCKING PROGRAM

Standard Lock

- All storage units except bookcases are equipped with a single lock system. Cabinets/Lateral files combos have 2 locks.
- Each key lock has a factory-installed lock plug and key numbers are attributed in random fashion.
- It is possible to change lock plugs and install a keyed alike system. Master Key and Control Key also offered. For further information, contact the Groupe Lacasse Customer Service.
- The locking system accepts a key lock (standard) or an electronic lock (option).

Electronic Lock (option)

- The Versa Mini, from Numeris by Digilock, is an electronic lock intended to secure storage furniture for hospitality, retail and healthcare professionals.
- When specified in option, the electronic lock (D) is factory installed. A key lock on an existing unit can be changed for an electronic lock (see page 14).
- Installed horizontally with keypad on the left on a file and vertically installed with keypad at top on a cabinet or a wardrobe.

- The lock uses 2 small coin cell lithium batteries for an average of 50,000 actuations. The battery compartment is located within the front of the lock to allow changing batteries without unlocking or opening the door.
- The keypad interface allows the user to operate the lock with a 4 to 7-digit user code for a multitude of combinations.
- Manager Keys (sold separately, see page 14) provide bypass access in case the user is unable to access their storage unit. It can also operate the locks in case of battery failure. Manager Keys are programmed into the lock system by a unique Programming Key (sold separately, see page 14).
- The lock is programmed to assigned use functionality by default, which allows up to 20 simultaneous user codes. It can be easily changed to shared use functionality with a Programming Key.
- In shared use, the lock is designed for day use applications. The user chooses an available storage unit and operates it with a self-selected user credential code. Once the storage unit is vacated, it becomes available for a different user.

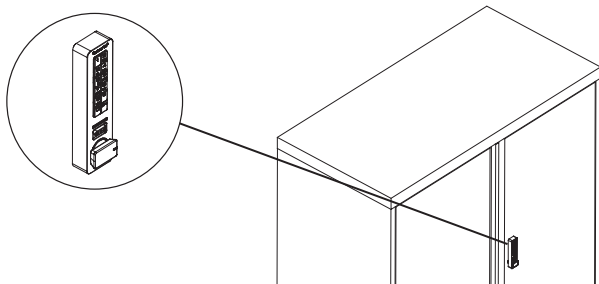

Vertical installation

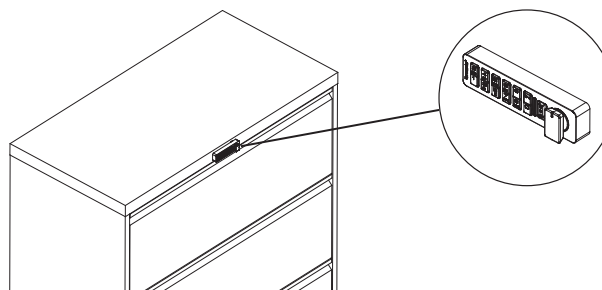

Horizontal installation

LATERAL FILES

- 15 different configurations are possible; 2, 3, 4, 5 or 6-high, 30" W (762 mm), 36" W (914 mm) or 42" W (1067 mm) and 18" D (457 mm).
- Drawers come with a fixed front (D) or a receding front and a roll-out shelf (R).
- A posting shelf (P) at a height of 40" (1016 mm) is available in option to make reading and filing easier. Offered on 4, 5 and 6-drawer files.
- On all configurations, the 1st drawer from the bottom has a fixed front (D). The 5th drawer has a receding front with a roll-out shelf (R). The 6th drawer has a receding front and a fixed shelf (F).

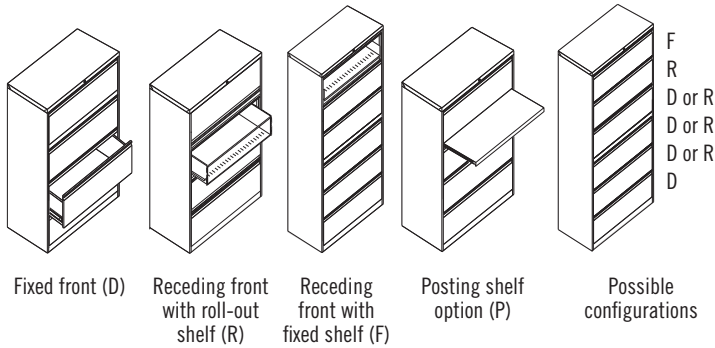

- Drawers are 12" H (305 mm) and can accommodate letter, legal or A4-size documents.
- In order to meet ANSI/BIFMA stability standards, lateral file must be installed under a work surface, be attached or have a counterweight (not required for 5 or 6-drawer files).
- A lock is installed above the highest drawer, allowing to lock all drawers at once.

- Drawers and roll-out shelves are equipped with full-extension telescopic slides. The ball-bearing system is designed to support intensive use.
- The 2-drawer file is also offered in universal height that fits under a 28" H (711 mm) work surface. That file doesn't offer the same visual compatibility when side-to-side with other units from this collection.
- Label holder included on each integrated pull for easy identification.
- Two hanging bars are included with each drawer to allow side-to-side filing. For front-to-back filing and dividers, see page 14.

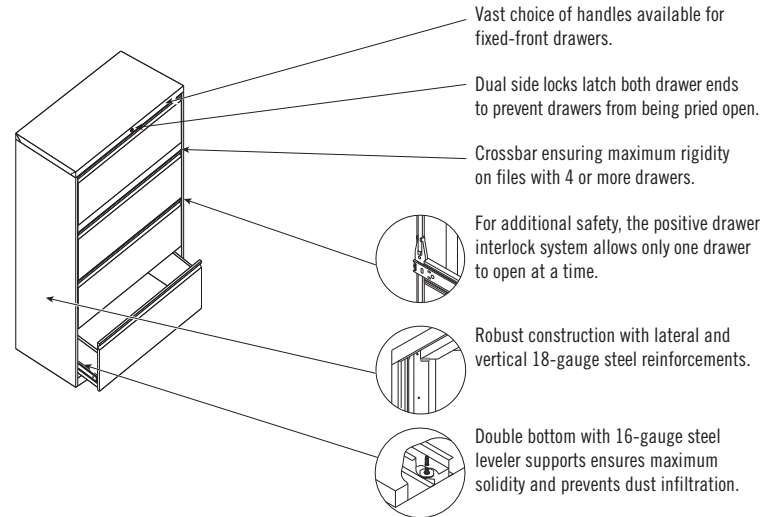

CABINETS AND BOOKCASES

- 15 different configurations are possible; 2, 3, 4, 5 or 6 compartments high, 30" W (762 mm), 36" W (914 mm) or 42" W (1067 mm) and 18" D (457 mm).
- Cabinets and bookcases meet ANSI/BIFMA stability standards.
- A half-height lock is installed on the right door of the cabinet and allows to lock the 2 doors, from the bottom up.
- Interior space allows to store standard binders on all shelves except one (ex.: a 4-compartment cabinet or bookcase can hold binders on 3 shelves only).
- Shelves are adjustable every 1½" (38 mm). Additional shelves are available (see page 14).

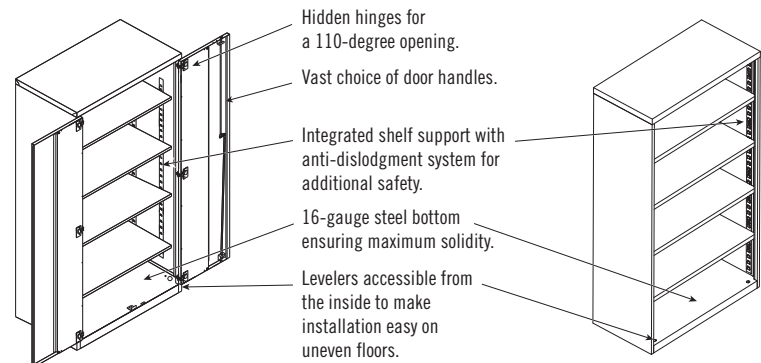

WARDROBES

- 8 different configurations are possible; hinges on left/right, 53 ³/₈" H (1356 mm) and 65 ¹/₂" H (1664 mm), 15" W (381 mm) or 18" W (457 mm) and 24" D (610 mm).
- Wardrobes meet ANSI/BIFMA stability standards.
- A half-height lock is installed on the door.
- A fixed shelf with a clothing hanger bar is located at 7 ¹/₂" H (191 mm) from the top and allows the storage of personal effects.

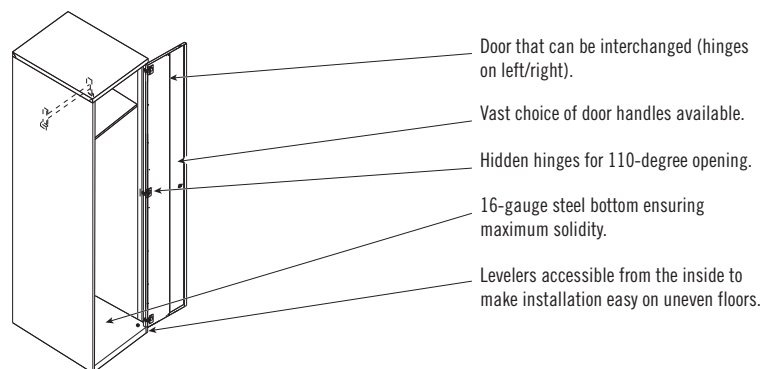

CABINETS / LATERAL FILES COMBOS

- 12 different configurations are possible; 2, 3, 4 or 5 compartments high, 30" W (762 mm), 36" W (914 mm) or 42" W (1067 mm) and 18" D (457 mm).
- In order to meet ANSI/BIFMA stability standards, 53 ³/₈" H (1356 mm) or less cabinets/files must be attached or have a counterweight.
- Two independent locks for cabinet and drawers.
- Drawers are equipped with full-extension telescopic slides. The ball-bearing system is designed to support intensive use.
- Label holder included on each integrated pull for easy identification.
- Two hanging bars are included with each drawer to allow side-to-side filing. For front-to-back filing and dividers, see page 14.
- Shelves are adjustable every 1 ¹/₂" (38 mm). Additional shelves are available (see page 14).

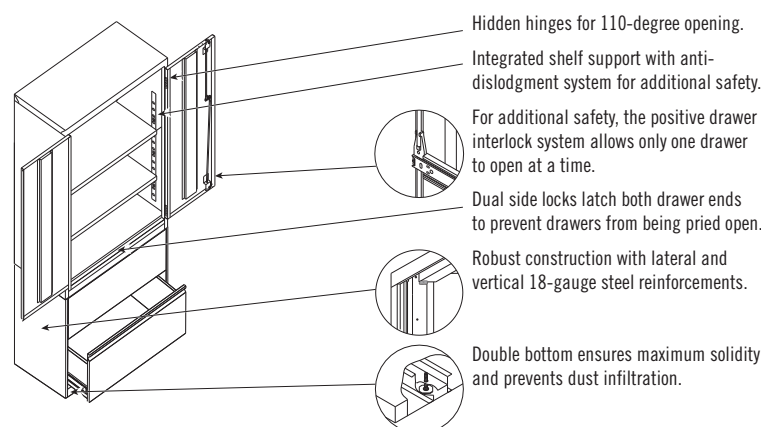

MULTIFUNCTION FILES

- 6 different configurations are possible; left or right box drawers, 30" W (762 mm), 36" W (914 mm) or 42" W (1067 mm) and 18" D (457 mm).
- In order to meet ANSI/BIFMA stability standards, multifunction files must be installed under a work surface, be attached or have a counterweight.
- Box drawers width is 12" (305 mm) for a 30" W (914 mm) unit, 18" (457 mm) for a 36" W (914 mm) unit, and 24" (610 mm) for a 42" W (1067 mm) unit.
- Central lock locks all drawers at once.
- Pencil tray included in the first box drawer.
- Label holder included on each integrated pull for easy identification.
- Two hanging bars are included with file drawers to allow side-to-side filing. For front-to-back filing and dividers, see page 14.
- Laminate tops and cushions are available. See pages 13 and 14.

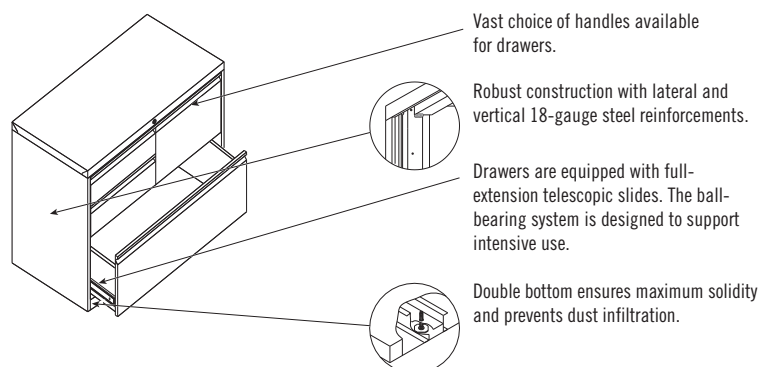

SPECIFICATIONS

LOW STORAGE UNITS

- 6 different configurations are possible; 2 drawers, 1 drawer with pigeonhole and 2 open compartments, 30" W (762 mm) or 36" W (914 mm) and 18" D (457 mm).
- In order to meet ANSI/BIFMA stability standards, low storage units with drawer(s) must be anchored to a wall or ganged to another unit, or have a counterweight.
- Central lock locks all drawers at once.
- For additional safety, the positive drawer interlock system allows only one drawer to open at a time (on 2-drawer units).
- Label holder included on each integrated pull for easy identification.
- Two hanging bars are included with file drawer to allow side-to-side filing. For front-to-back filing and dividers, see page 14.
- Dividers are available for utility drawer. Laminate tops and cushions are also available. See pages 13 and 14.

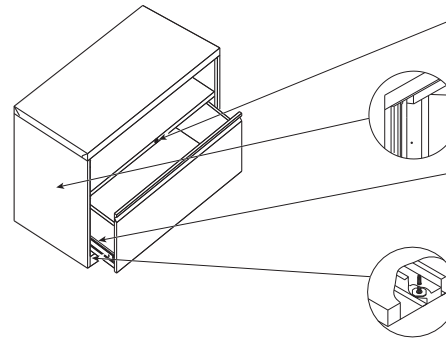

Dual side locks latch both drawer ends to prevent drawers from being pried open.

Robust construction with lateral and vertical 18-gauge steel reinforcements.

Drawers are equipped with full-extension telescopic slides. The ball-bearing system is designed to support intensive use.

Double bottom ensures maximum solidity and prevents dust infiltration.

VERTICAL FILES

- 8 different configurations are possible; 2, 3, 4 or 5-high, 14³/₄" W (375 mm) or 17³/₄" W (451 mm) and 28" D (711 mm).
- In order to meet ANSI/BIFMA stability standards, vertical files with 3 or less drawers must be attached or have a counterweight.
- Drawers are 12" H (305 mm) and can accommodate letter, legal or A4-size documents. They are available with fixed front (D).
- A lock is installed above the highest drawer, allowing to lock all drawers at once.
- Label holder included on each integrated pull for easy identification.
- Full-height sides of drawers allow front-rear filing. For dividers and compressors, see page 14.

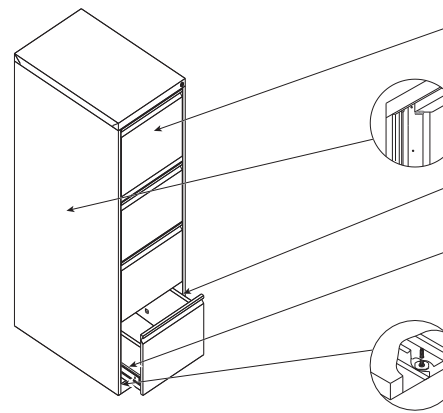

Vast choice of handles available for drawers.

Robust construction with lateral and vertical 18-gauge steel reinforcements.

Two hanging bars are included with each drawer to allow side-to-side filing.

Drawers are equipped with full-extension telescopic slides. The ball-bearing system is designed to support intensive use.

Double bottom with 16-gauge steel leveler supports ensures maximum solidity and prevents dust infiltration.

METAL STORAGE FURNITURE

SPECIFICATIONS

INTEGRATED PULLS



F – Full

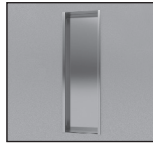

R – Recessed
Non-painted
aluminum

EXTERNAL PULLS

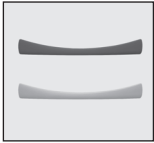

K – Classic

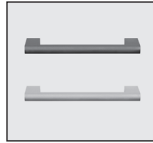

Z – Straight

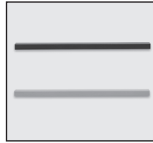

M – Modern



W – Modern
White

ACCENT COLORS



A – Anthracite Grey



S – Silver

LOCKS

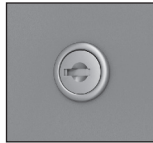

Standard



D – Electronic
Black or Nickel

READY TO SHIP IN 5 DAYS!

Several products and accessories identified by this pictogram are part of the **QuickShip** program.



CODIFICATION

Series	Options		
	Drawers	Pulls	Accent
RI	D Fixed front(s) R Recessed front(s)	F Full R Recessed Z Straight K Classic M Modern W White modern	A Anthracite Grey S Silver

OPTIONS INTEGRATION

Electronic lock: indicate **D** at the end of the code and add **\$420** to price.

Ex: **RIDFA-184254LF4D**

Counterweight: indicate **W** at the end of the code and add **\$175** to price. Factory installed only. Ex: **RIDFA-183028LF2W**

Posting shelf for lateral files with 4 or more drawers: indicate **P** at the end of the code and add **\$185** to price. Ex: **RIDFA-183054LF4P**

METAL STORAGE FURNITURE - PAINT COLORS

Standard Colors

P01 Crystal Black	P44 Metallic Silver
P04 Charcoal	P53 Snow
P17 Beige	P54 Chalk
P28 Anthracite Grey	P55 Arctic Grey
P29 Willow Grey	P57 Storm
P30 Grey Tone	P58 Velvet
P42 Smoke	

Trendy Colors*

P70 Red	P75 Aqua
P71 Orange	P76 Chartreuse
P72 Yellow	P77 Emerald
P73 Blue	P78 Midnight Blue
P74 Plum	

* Add 10% to unit price including upcharge for posting (P) shelf option, if applicable. Paint upcharge is not applicable on options such as electronic lock or counterweight.

TOP - THERMOFUSED LAMINATE / HIGH-PRESSURE LAMINATE FINISHES

Wood Grain Finishes

ACA Mahogany
BUC Bourbon Cherry
CAR Caramello
CER Cherry
CCL Classic Chocolate
DCH Dark Chocolate
ERH Hard Rock Maple
FOS Fossil
GGI Grigio
HZN Hazelnut
MTA Musta
NTL Natural Cherry
RBV Ruby

(cont'd)

SLT Salta
TOM Totem
TWT Tuscany Walnut

Solid Colors

GAN Anthracite Grey
NCN Crystal Black
SNO Snow
WGR Willow Grey

Patterns

GVR Frost
PCM Parchment

CUSHIONS - CHOICE OF UPHOLSTERY

Several choices of upholstery are available. Please refer to the United Chair® Standard Upholstery Program.

TOP - EDGEBANDING

N Edge

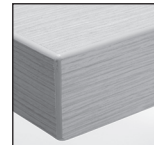









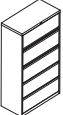
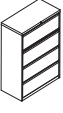
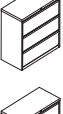

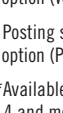

Smooth, 1/8" (3 mm) thick edge.

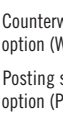
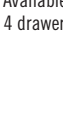
The **N** edge is **matched with the finish specified for the surface.**



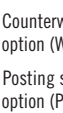
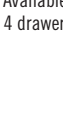



CODIFICATION









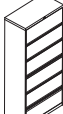
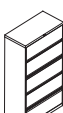

Series	Options	
	Finishes / thickness	Edgebanding
R	1 Thermofused laminate top 1" 2 High-pressure laminate top 1" 5 Thermofused laminate top 1½" 6 High-pressure laminate top 1½"	N Smooth edge

	W x D x H (in)	W x D x H (mm)	Code	Price (\$)
LATERAL FILES				
Fixed-front lateral files - integrated pulls				
<i>The 5th drawer has a receding front with a roll-out shelf. The 6th drawer has a receding front with a fixed shelf. In order to comply with ANSI/BIFMA, a counterweight or anchoring solution is required for files with 4 or less drawers.</i>				
6-high.				
	42 x 18 x 77 ⁵ / ₈	1067 x 457 x 1972	RID__-184278LF6	2,865
	36 x 18 x 77 ⁵ / ₈	914 x 457 x 1972	RID__-183678LF6	2,360
	30 x 18 x 77 ⁵ / ₈	762 x 457 x 1972	RID__-183078LF6	2,285
Fixed fronts (D). Specify the pull code (F, R). Specify the accent color (A, S).				
5-high.				
	42 x 18 x 65 ¹ / ₂	1067 x 457 x 1664	RID__-184266LF5	2,285
	36 x 18 x 65 ¹ / ₂	914 x 457 x 1664	RID__-183666LF5	1,775
	30 x 18 x 65 ¹ / ₂	762 x 457 x 1664	RID__-183066LF5	1,730
Fixed fronts (D). Specify the pull code (F, R). Specify the accent color (A, S).				
4-high.				
	42 x 18 x 53 ³ / ₈	1067 x 457 x 1356	RID__-184254LF4	1,770
	36 x 18 x 53 ³ / ₈	914 x 457 x 1356	RID__-183654LF4	1,440
	30 x 18 x 53 ³ / ₈	762 x 457 x 1356	RID__-183054LF4	1,430
Fixed fronts (D). Specify the pull code (F, R). Specify the accent color (A, S).				
3-high.				
	42 x 18 x 40 ¹ / ₁₆	1067 x 457 x 1018	RID__-184241LF3	1,405
	36 x 18 x 40 ¹ / ₁₆	914 x 457 x 1018	RID__-183641LF3	1,145
	30 x 18 x 40 ¹ / ₁₆	762 x 457 x 1018	RID__-183041LF3	1,110
Fixed fronts (D). Specify the pull code (F, R). Specify the accent color (A, S).				
2-high.				
	42 x 18 x 27 ¹ / ₈	1067 x 457 x 708	RID__-184228LF2	1,015
	36 x 18 x 27 ¹ / ₈	914 x 457 x 708	RID__-183628LF2	855
	30 x 18 x 27 ¹ / ₈	762 x 457 x 708	RID__-183028LF2	785
Fixed fronts (D). Specify the pull code (F, R). Specify the accent color (A, S).				
2-high, universal height.				
	42 x 18 x 26 ¹ / ₈	1067 x 457 x 683	RID__-184227LF2	1,015
	36 x 18 x 26 ¹ / ₈	914 x 457 x 683	RID__-183627LF2	855
	30 x 18 x 26 ¹ / ₈	762 x 457 x 683	RID__-183027LF2	785
Fixed fronts (D). Specify the pull code (F, R). Specify the accent color (A, S).				
Fixed-front lateral files - external pulls				
<i>In order to comply with ANSI/BIFMA, a counterweight or anchoring solution is required.</i>				
4-high.				
	42 x 18 x 53 ³ / ₈	1067 x 457 x 1356	RID__-184254LF4	1,770
	36 x 18 x 53 ³ / ₈	914 x 457 x 1356	RID__-183654LF4	1,440
	30 x 18 x 53 ³ / ₈	762 x 457 x 1356	RID__-183054LF4	1,430
Fixed fronts (D). Specify the pull code (K, M, Z, W). Specify the accent color (A, S).				
3-high.				
	42 x 18 x 40 ¹ / ₁₆	1067 x 457 x 1018	RID__-184241LF3	1,405
	36 x 18 x 40 ¹ / ₁₆	914 x 457 x 1018	RID__-183641LF3	1,145
	30 x 18 x 40 ¹ / ₁₆	762 x 457 x 1018	RID__-183041LF3	1,110
Fixed fronts (D). Specify the pull code (K, M, Z, W). Specify the accent color (A, S).				







Electronic lock option (D): add \$420.
Counterweight option (W): add \$175.
Posting shelf option (P)*: add \$185.
*Available on file with 4 and more drawers.

Electronic lock option (D): add \$420.
Counterweight option (W): add \$175.
Posting shelf option (P)*: add \$185.
*Available on file with 4 drawers.

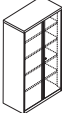
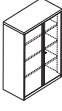
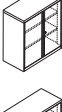

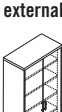
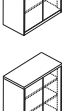
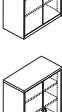
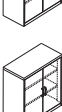
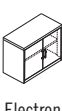

	W x D x H (in)	W x D x H (mm)	Code	Price (\$)
Fixed-front lateral files - external pulls (cont'd)				
2-high.				
	42 x 18 x 27 ¹ / ₈	1067 x 457 x 708	RID__-184228LF2	1,015
	36 x 18 x 27 ¹ / ₈	914 x 457 x 708	RID__-183628LF2	855
	30 x 18 x 27 ¹ / ₈	762 x 457 x 708	RID__-183028LF2	785
Fixed fronts (D). Specify the pull code (K, M, Z, W). Specify the accent color (A, S).				
2-high, universal height.				
	42 x 18 x 26 ¹ / ₈	1067 x 457 x 683	RID__-184227LF2	1,015
	36 x 18 x 26 ¹ / ₈	914 x 457 x 683	RID__-183627LF2	855
	30 x 18 x 26 ¹ / ₈	762 x 457 x 683	RID__-183027LF2	785
Fixed fronts (D). Specify the pull code (K, M, Z, W). Specify the accent color (A, S).				

	W x D x H (in)	W x D x H (mm)	Code	Price (\$)
Receding-front lateral files - integrated pulls				
<i>The 1st drawer from the bottom has a fixed front. The 6th drawer has a receding front with a fixed shelf. In order to comply with ANSI/BIFMA, a counterweight or anchoring solution is required for files with 4 or less drawers.</i>				
6-high.				
	42 x 18 x 77 ⁵ / ₈	1067 x 457 x 1972	RIR__-184278LF6	3,085
	36 x 18 x 77 ⁵ / ₈	914 x 457 x 1972	RIR__-183678LF6	2,785
	30 x 18 x 77 ⁵ / ₈	762 x 457 x 1972	RIR__-183078LF6	2,765
Receding fronts (R). Specify the pull code (F, R). Specify the accent color (A, S).				
5-high.				
	42 x 18 x 65 ¹ / ₂	1067 x 457 x 1664	RIR__-184266LF5	2,555
	36 x 18 x 65 ¹ / ₂	914 x 457 x 1664	RIR__-183666LF5	2,200
	30 x 18 x 65 ¹ / ₂	762 x 457 x 1664	RIR__-183066LF5	2,160
Receding fronts (R). Specify the pull code (F, R). Specify the accent color (A, S).				
4-high.				
	42 x 18 x 53 ³ / ₈	1067 x 457 x 1356	RIR__-184254LF4	2,115
	36 x 18 x 53 ³ / ₈	914 x 457 x 1356	RIR__-183654LF4	1,830
	30 x 18 x 53 ³ / ₈	762 x 457 x 1356	RIR__-183054LF4	1,700
Receding fronts (R). Specify the pull code (F, R). Specify the accent color (A, S).				
3-high.				
	42 x 18 x 40 ¹ / ₁₆	1067 x 457 x 1018	RIR__-184241LF3	1,640
	36 x 18 x 40 ¹ / ₁₆	914 x 457 x 1018	RIR__-183641LF3	1,470
	30 x 18 x 40 ¹ / ₁₆	762 x 457 x 1018	RIR__-183041LF3	1,455
Receding fronts (R). Specify the pull code (F, R). Specify the accent color (A, S).				
2-high.				
	42 x 18 x 27 ¹ / ₈	1067 x 457 x 708	RIR__-184228LF2	1,400
	36 x 18 x 27 ¹ / ₈	914 x 457 x 708	RIR__-183628LF2	1,125
	30 x 18 x 27 ¹ / ₈	762 x 457 x 708	RIR__-183028LF2	1,045
Receding front (R). Specify the pull code (F, R). Specify the accent color (A, S).				



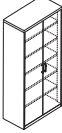
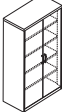
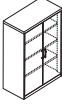
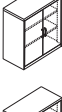
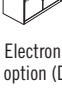





Electronic lock option (D): add \$420.
Counterweight option (W): add \$175.
Posting shelf option (P)*: add \$185.
*Available on file with 4 and more drawers.

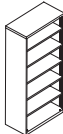
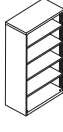

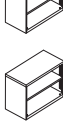

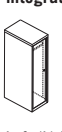
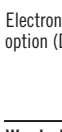
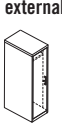
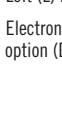



	W x D x H (in)	W x D x H (mm)	Code	Price (\$)
CABINETS				
Cabinets - integrated pulls	<i>6 compartments (5 adjustable shelves).</i>			
	42 x 18 x 77 ³ / ₈	1067 x 457 x 1972	RIN__-421878B	1,715
	36 x 18 x 77 ³ / ₈	914 x 457 x 1972	RIN__-361878B	1,625
	30 x 18 x 77 ³ / ₈	762 x 457 x 1972	RIN__-301878B	1,530
Specify the pull code (F, R). Specify the accent color (A, S).				
	<i>5 compartments (4 adjustable shelves).</i>			
	42 x 18 x 65 ¹ / ₂	1067 x 457 x 1664	RIN__-421866B	1,420
	36 x 18 x 65 ¹ / ₂	914 x 457 x 1664	RIN__-361866B	1,320
	30 x 18 x 65 ¹ / ₂	762 x 457 x 1664	RIN__-301866B	1,270
Specify the pull code (F, R). Specify the accent color (A, S).				
	<i>4 compartments (3 adjustable shelves).</i>			
	42 x 18 x 53 ³ / ₈	1067 x 457 x 1356	RIN__-421854B	1,235
	36 x 18 x 53 ³ / ₈	914 x 457 x 1356	RIN__-361854B	1,145
	30 x 18 x 53 ³ / ₈	762 x 457 x 1356	RIN__-301854B	1,100
Specify the pull code (F, R). Specify the accent color (A, S).				
	<i>3 compartments (2 adjustable shelves).</i>			
	42 x 18 x 40 ¹ / ₁₆	1067 x 457 x 1018	RIN__-421841B	1,065
	36 x 18 x 40 ¹ / ₁₆	914 x 457 x 1018	RIN__-361841B	985
	30 x 18 x 40 ¹ / ₁₆	762 x 457 x 1018	RIN__-301841B	945
Specify the pull code (F, R). Specify the accent color (A, S).				
	<i>2 compartments (1 adjustable shelf).</i>			
	42 x 18 x 27 ¹ / ₈	1067 x 457 x 708	RIN__-421828B	860
	36 x 18 x 27 ¹ / ₈	914 x 457 x 708	RIN__-361828B	810
	30 x 18 x 27 ¹ / ₈	762 x 457 x 708	RIN__-301828B	785
Specify the pull code (F, R). Specify the accent color (A, S).				

Electronic lock option (D): add \$420.

Cabinets - external pulls	<i>6 compartments (5 adjustable shelves).</i>			
	42 x 18 x 77 ³ / ₈	1067 x 457 x 1972	RIN__-421878B	1,715
	36 x 18 x 77 ³ / ₈	914 x 457 x 1972	RIN__-361878B	1,625
	30 x 18 x 77 ³ / ₈	762 x 457 x 1972	RIN__-301878B	1,530
Specify the pull code (K, M, Z, W). Specify the accent color (A, S).				
	<i>5 compartments (4 adjustable shelves).</i>			
	42 x 18 x 65 ¹ / ₂	1067 x 457 x 1664	RIN__-421866B	1,420
	36 x 18 x 65 ¹ / ₂	914 x 457 x 1664	RIN__-361866B	1,320
	30 x 18 x 65 ¹ / ₂	762 x 457 x 1664	RIN__-301866B	1,270
Specify the pull code (K, M, Z, W). Specify the accent color (A, S).				
	<i>4 compartments (3 adjustable shelves).</i>			
	42 x 18 x 53 ³ / ₈	1067 x 457 x 1356	RIN__-421854B	1,235
	36 x 18 x 53 ³ / ₈	914 x 457 x 1356	RIN__-361854B	1,145
	30 x 18 x 53 ³ / ₈	762 x 457 x 1356	RIN__-301854B	1,100
Specify the pull code (K, M, Z, W). Specify the accent color (A, S).				
	<i>3 compartments (2 adjustable shelves).</i>			
	42 x 18 x 40 ¹ / ₁₆	1067 x 457 x 1018	RIN__-421841B	1,065
	36 x 18 x 40 ¹ / ₁₆	914 x 457 x 1018	RIN__-361841B	985
	30 x 18 x 40 ¹ / ₁₆	762 x 457 x 1018	RIN__-301841B	945
Specify the pull code (K, M, Z, W). Specify the accent color (A, S).				
	<i>2 compartments (1 adjustable shelf).</i>			
	42 x 18 x 27 ¹ / ₈	1067 x 457 x 708	RIN__-421828B	860
	36 x 18 x 27 ¹ / ₈	914 x 457 x 708	RIN__-361828B	810
	30 x 18 x 27 ¹ / ₈	762 x 457 x 708	RIN__-301828B	785
Specify the pull code (K, M, Z, W). Specify the accent color (A, S).				







Electronic lock option (D): add \$420.

	W x D x H (in)	W x D x H (mm)	Code	Price (\$)
BOOKCASES				
	<i>6 compartments (5 adjustable shelves).</i>			
	42 x 18 x 77 ³ / ₈	1067 x 457 x 1972	RINNN-B427818	1,435
	36 x 18 x 77 ³ / ₈	914 x 457 x 1972	RINNN-B367818	1,330
	30 x 18 x 77 ³ / ₈	762 x 457 x 1972	RINNN-B307818	1,255
	<i>5 compartments (4 adjustable shelves).</i>			
	42 x 18 x 65 ¹ / ₂	1067 x 457 x 1664	RINNN-B426618	1,135
	36 x 18 x 65 ¹ / ₂	914 x 457 x 1664	RINNN-B366618	975
	30 x 18 x 65 ¹ / ₂	762 x 457 x 1664	RINNN-B306618	910
	<i>4 compartments (3 adjustable shelves).</i>			
	42 x 18 x 53 ³ / ₈	1067 x 457 x 1356	RINNN-B425418	905
	36 x 18 x 53 ³ / ₈	914 x 457 x 1356	RINNN-B365418	840
	30 x 18 x 53 ³ / ₈	762 x 457 x 1356	RINNN-B305418	780
	<i>3 compartments (2 adjustable shelves).</i>			
	42 x 18 x 40 ¹ / ₁₆	1067 x 457 x 1018	RINNN-B424118	760
	36 x 18 x 40 ¹ / ₁₆	914 x 457 x 1018	RINNN-B364118	680
	30 x 18 x 40 ¹ / ₁₆	762 x 457 x 1018	RINNN-B304118	640
	<i>2 compartments (1 adjustable shelf).</i>			
	42 x 18 x 27 ¹ / ₈	1067 x 457 x 708	RINNN-B422818	650
	36 x 18 x 27 ¹ / ₈	914 x 457 x 708	RINNN-B362818	600
	30 x 18 x 27 ¹ / ₈	762 x 457 x 708	RINNN-B302818	575

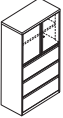
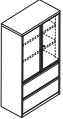
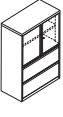



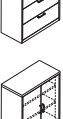
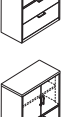
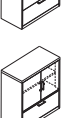
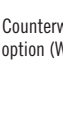

	W x D x H (in)	W x D x H (mm)	Code	Price (\$)
WARDROBES				
Wardrobes - integrated pulls	<i>18" (457 mm) wide.</i>			
	18 x 24 x 65 ¹ / ₂	457 x 610 x 1664	RIN__-241866B__	1,190
	18 x 24 x 53 ³ / ₈	457 x 610 x 1356	RIN__-241854B__	1,090
Specify the pull code (F, R). Specify the accent color (A, S). Specify the door opening at the end of the code: hinges on left (L) or hinges on right (R).				
	<i>15" (381 mm) wide.</i>			
	15 x 24 x 65 ¹ / ₂	381 x 610 x 1664	RIN__-241566B__	1,020
	15 x 24 x 53 ³ / ₈	381 x 610 x 1356	RIN__-241554B__	970
Specify the pull code (F, R). Specify the accent color (A, S). Specify the door opening at the end of the code: hinges on left (L) or hinges on right (R).				
Wardrobes - external pulls	<i>18" (457 mm) wide.</i>			
	18 x 24 x 65 ¹ / ₂	457 x 610 x 1664	RIN__-241866B__	1,190
	18 x 24 x 53 ³ / ₈	457 x 610 x 1356	RIN__-241854B__	1,090
Specify the pull code (K, M, Z, W). Specify the accent color (A, S). Specify the door opening at the end of the code: hinges on left (L) or hinges on right (R).				
	<i>15" (381 mm) wide.</i>			
	15 x 24 x 65 ¹ / ₂	381 x 610 x 1664	RIN__-241566B__	1,020
	15 x 24 x 53 ³ / ₈	381 x 610 x 1356	RIN__-241554B__	970
Specify the pull code (K, M, Z, W). Specify the accent color (A, S). Specify the door opening at the end of the code: hinges on left (L) or hinges on right (R).				

Left (L) Right (R)
Electronic lock option (D): add \$420.

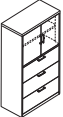
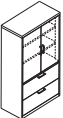
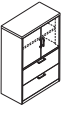





Left (L) Right (R)
Electronic lock option (D): add \$420.

	W x D x H (in)	W x D x H (mm)	Code	Price (\$)
MULTIFUNCTION STORAGE FURNITURE				
Cabinets / Lateral Files Combos - integrated pulls	<i>In order to comply with ANSI/BIFMA standards, a counterweight or anchoring solution is required on storage units 53 3/8" H (1356 mm) or less.</i>			
	<i>3 full width drawers, closed cabinet 23" H (584 mm) with 1 adjustable shelf.</i>			
	42 x 18 x 65 1/2	1067 x 457 x 1664	RID__-184266LF3B	2,515
	36 x 18 x 65 1/2	914 x 457 x 1664	RID__-183666LF3B	2,215
	30 x 18 x 65 1/2	762 x 457 x 1664	RID__-183066LF3B	2,170
	Fixed fronts (D). Specify the pull code (F, R). Specify the accent color (A, S).			
	<i>2 full width drawers, closed cabinet 35" H (889 mm) with 2 adjustable shelves.</i>			
	42 x 18 x 65 1/2	1067 x 457 x 1664	RID__-184266LF2B	2,355
	36 x 18 x 65 1/2	914 x 457 x 1664	RID__-183666LF2B	2,100
	30 x 18 x 65 1/2	762 x 457 x 1664	RID__-183066LF2B	2,000
	Fixed fronts (D). Specify the pull code (F, R). Specify the accent color (A, S).			
	<i>2 full width drawers, closed cabinet 23" H (584 mm) with 1 adjustable shelf.</i>			
	42 x 18 x 53 3/8	1067 x 457 x 1356	RID__-184254LF2B	2,130
	36 x 18 x 53 3/8	914 x 457 x 1356	RID__-183654LF2B	1,900
	30 x 18 x 53 3/8	762 x 457 x 1356	RID__-183054LF2B	1,855
	Fixed fronts (D). Specify the pull code (F, R). Specify the accent color (A, S).			
	<i>1 full width drawer, closed cabinet 23" H (584 mm) with 1 adjustable shelf.</i>			
	42 x 18 x 40 1/16	1067 x 457 x 1018	RID__-184241LFB	2,030
	36 x 18 x 40 1/16	914 x 457 x 1018	RID__-183641LFB	1,730
	30 x 18 x 40 1/16	762 x 457 x 1018	RID__-183041LFB	1,685
	Fixed fronts (D). Specify the pull code (F, R). Specify the accent color (A, S).			

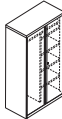

Counterweight option (W): add \$175.

Cabinets / Lateral Files Combos - external pulls	<i>In order to comply with ANSI/BIFMA standards, a counterweight or anchoring solution is required on storage units 53 3/8" H (1356 mm) or less.</i>			
	<i>3 full width drawers, closed cabinet 23" H (584 mm) with 1 adjustable shelf.</i>			
	42 x 18 x 65 1/2	1067 x 457 x 1664	RID__-184266LF3B	2,515
	36 x 18 x 65 1/2	914 x 457 x 1664	RID__-183666LF3B	2,215
	30 x 18 x 65 1/2	762 x 457 x 1664	RID__-183066LF3B	2,170
	Fixed fronts (D). Specify the pull code (K, M, Z, W). Specify the accent color (A, S).			
	<i>2 full width drawers, closed cabinet 35" H (889 mm) with 2 adjustable shelves.</i>			
	42 x 18 x 65 1/2	1067 x 457 x 1664	RID__-184266LF2B	2,355
	36 x 18 x 65 1/2	914 x 457 x 1664	RID__-183666LF2B	2,100
	30 x 18 x 65 1/2	762 x 457 x 1664	RID__-183066LF2B	2,000
	Fixed fronts (D). Specify the pull code (K, M, Z, W). Specify the accent color (A, S).			
	<i>2 full width drawers, closed cabinet 23" H (584 mm) with 1 adjustable shelf.</i>			
	42 x 18 x 53 3/8	1067 x 457 x 1356	RID__-184254LF2B	2,130
	36 x 18 x 53 3/8	914 x 457 x 1356	RID__-183654LF2B	1,900
	30 x 18 x 53 3/8	762 x 457 x 1356	RID__-183054LF2B	1,855
	Fixed fronts (D). Specify the pull code (K, M, Z, W). Specify the accent color (A, S).			
	<i>1 full width drawer, closed cabinet 23" H (584 mm) with 1 adjustable shelf.</i>			
	42 x 18 x 40 1/16	1067 x 457 x 1018	RID__-184241LFB	2,030
	36 x 18 x 40 1/16	914 x 457 x 1018	RID__-183641LFB	1,730
	30 x 18 x 40 1/16	762 x 457 x 1018	RID__-183041LFB	1,685
	Fixed fronts (D). Specify the pull code (K, M, Z, W). Specify the accent color (A, S).			





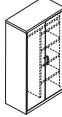
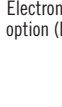

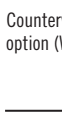
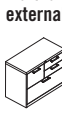
Counterweight option (W): add \$175.

	W x D x H (in)	W x D x H (mm)	Code	Price (\$)
Cabinets / Wardrobes Combos - integrated pulls	<i>1 full width fixed shelf, 1 clothes hanger bar, 4 adjustable half shelves.</i>			
	42 x 18 x 77 1/8	1067 x 457 x 1972	RIN__-421878BC	2,030
	36 x 18 x 77 1/8	914 x 457 x 1972	RIN__-361878BC	1,915
	30 x 18 x 77 1/8	762 x 457 x 1972	RIN__-301878BC	1,870
	Specify the pull code (F, R). Specify the accent color (A, S).			
	<i>1 full width fixed shelf, 1 clothes hanger bar, 3 adjustable half shelves.</i>			
	42 x 18 x 65 1/2	1067 x 457 x 1664	RIN__-421866BC	1,970
	36 x 18 x 65 1/2	914 x 457 x 1664	RIN__-361866BC	1,870
	30 x 18 x 65 1/2	762 x 457 x 1664	RIN__-301866BC	1,840
	Specify the pull code (F, R). Specify the accent color (A, S).			

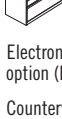
Electronic lock option (D): add \$420.

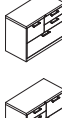
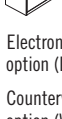

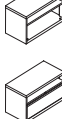



Cabinets / Wardrobes Combos - external pulls	<i>1 full width fixed shelf, 1 clothes hanger bar, 4 adjustable half shelves.</i>			
	42 x 18 x 77 1/8	1067 x 457 x 1972	RIN__-421878BC	2,030
	36 x 18 x 77 1/8	914 x 457 x 1972	RIN__-361878BC	1,915
	30 x 18 x 77 1/8	762 x 457 x 1972	RIN__-301878BC	1,870
	Specify the pull code (K, M, Z, W). Specify the accent color (A, S).			
	<i>1 full width fixed shelf, 1 clothes hanger bar, 3 adjustable half shelves.</i>			
	42 x 18 x 65 1/2	1067 x 457 x 1664	RIN__-421866BC	1,970
	36 x 18 x 65 1/2	914 x 457 x 1664	RIN__-361866BC	1,870
	30 x 18 x 65 1/2	762 x 457 x 1664	RIN__-301866BC	1,840
	Specify the pull code (K, M, Z, W). Specify the accent color (A, S).			

Electronic lock option (D): add \$420.

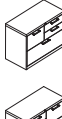
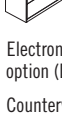
Multifunction files - integrated pulls	<i>In order to comply with ANSI/BIFMA standards, a counterweight or anchoring solution is required.</i>			
	<i>1 full width file drawer, 1 file drawer on left, 2 box drawers on right.</i>			
	42 x 18 x 27 1/8	1067 x 457 x 708	RID__-C0184228	1,545
	36 x 18 x 27 1/8	914 x 457 x 708	RID__-C0183628	1,415
	30 x 18 x 27 1/8	762 x 457 x 708	RID__-C0183028	1,385
	Fixed fronts (D). Specify the pull code (F, R). Specify the accent color (A, S).			
	<i>1 full width file drawer, 1 file drawer on right, 2 box drawers on left.</i>			
	42 x 18 x 27 1/8	1067 x 457 x 708	RID__-184228C0	1,545
	36 x 18 x 27 1/8	914 x 457 x 708	RID__-183628C0	1,415
	30 x 18 x 27 1/8	762 x 457 x 708	RID__-183028C0	1,385
	Fixed fronts (D). Specify the pull code (F, R). Specify the accent color (A, S).			
	<i>1 full width file drawer, 1 file drawer on right, 2 box drawers on left.</i>			
	42 x 18 x 27 1/8	1067 x 457 x 708	RID__-184228C0	1,545
	36 x 18 x 27 1/8	914 x 457 x 708	RID__-183628C0	1,415
	30 x 18 x 27 1/8	762 x 457 x 708	RID__-183028C0	1,385
	Fixed fronts (D). Specify the pull code (K, M, Z, W). Specify the accent color (A, S).			

Electronic lock option (D): add \$420.

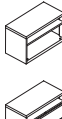
Counterweight option (W): add \$175.

Multifunction files - external pulls	<i>In order to comply with ANSI/BIFMA standards, a counterweight or anchoring solution is required on storage units.</i>			
	<i>1 full width file drawer, 1 file drawer on left, 2 box drawers on right.</i>			
	42 x 18 x 27 1/8	1067 x 457 x 708	RID__-C0184228	1,545
	36 x 18 x 27 1/8	914 x 457 x 708	RID__-C0183628	1,415
	30 x 18 x 27 1/8	762 x 457 x 708	RID__-C0183028	1,385
	Fixed fronts (D). Specify the pull code (K, M, Z, W). Specify the accent color (A, S).			
	<i>1 full width file drawer, 1 file drawer on right, 2 box drawers on left.</i>			
	42 x 18 x 27 1/8	1067 x 457 x 708	RID__-184228C0	1,545
	36 x 18 x 27 1/8	914 x 457 x 708	RID__-183628C0	1,415
	30 x 18 x 27 1/8	762 x 457 x 708	RID__-183028C0	1,385
	Fixed fronts (D). Specify the pull code (K, M, Z, W). Specify the accent color (A, S).			
Low storage units - integrated pulls	<i>In order to comply with ANSI/BIFMA standards, a counterweight or anchoring solution is required on storage units with drawer(s).</i>			
	<i>1 bookcase compartment, 1 pigeonhole.</i>			
	36 x 18 x 21 3/4	914 x 457 x 552	RINNN-BE361822	610
	30 x 18 x 21 3/4	762 x 457 x 552	RINNN-BE301822	560
	Fixed front (D). Specify the pull code (F, R). Specify the accent color (A, S).			
	<i>1 fixed-front file drawer, 1 pigeonhole.</i>			
	36 x 18 x 21 3/4	914 x 457 x 552	RID__-SLF361822	955
	30 x 18 x 21 3/4	762 x 457 x 552	RID__-SLF301822	920
	Fixed front (D). Specify the pull code (F, R). Specify the accent color (A, S).			



	W x D x H (in)	W x D x H (mm)	Code	Price (\$)
Low storage units - integrated pulls (cont'd)	<i>1 file drawer, 1 fixed-front utility drawer.</i>			
	36 x 18 x 21 3/4	914 x 457 x 552	RID__-UL361822	1,020
	30 x 18 x 21 3/4	762 x 457 x 552	RID__-UL301822	985



Electronic lock option (D)*: add \$420.

Counterweight option (W)*: add \$175.

*Not available on low storage units with open compartments.

	W x D x H (in)	W x D x H (mm)	Code	Price (\$)
Low storage units - external pulls	<i>In order to comply with ANSI/BIFMA standards, a counterweight or anchoring solution is required.</i>			
	<i>1 fixed-front file drawer, 1 pigeonhole.</i>			
	36 x 18 x 21 3/4	914 x 457 x 552	RID__-SLF361822	955
	30 x 18 x 21 3/4	762 x 457 x 552	RID__-SLF301822	920



Electronic lock option (D): add \$420.

Counterweight option (W): add \$175.

Fixed fronts (D). Specify the pull code (K, M, Z, W). Specify the accent color (A, S).

VERTICAL FILES

	W x D x H (in)	W x D x H (mm)	Code	Price (\$)
Vertical files - integrated pulls	<i>In order to comply with ANSI/BIFMA standards, a counterweight or anchoring solution is required on files with 3 or less drawers.</i>			
	<i>5-high.</i>			
	17 3/4 x 28 x 65 1/2	451 x 711 x 1664	RID__-281866VF5	1,560
	14 3/4 x 28 x 65 1/2	375 x 711 x 1664	RID__-281566VF5	1,560

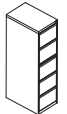

Electronic lock option (D): add \$420.

Counterweight option (W): add \$175.

Specify the pull code (F, R). Specify the accent color (A, S).

	<i>4-high.</i>			
	17 3/4 x 28 x 53 3/8	451 x 711 x 1356	RID__-281854VF4	1,250
	14 3/4 x 28 x 53 3/8	375 x 711 x 1356	RID__-281554VF4	1,250

Specify the pull code (F, R). Specify the accent color (A, S).

	<i>3-high.</i>			
	17 3/4 x 28 x 40 1/16	451 x 711 x 1018	RID__-281841VF3	1,095
	14 3/4 x 28 x 40 1/16	375 x 711 x 1018	RID__-281541VF3	1,095

Specify the pull code (F, R). Specify the accent color (A, S).

	<i>2-high.</i>			
	17 3/4 x 28 x 27 7/8	451 x 711 x 708	RID__-281828VF2	785
	14 3/4 x 28 x 27 7/8	375 x 711 x 708	RID__-281528VF2	785

Specify the pull code (F, R). Specify the accent color (A, S).

	W x D x H (in)	W x D x H (mm)	Code	Price (\$)
Vertical files - external pulls	<i>In order to comply with ANSI/BIFMA standards, a counterweight or anchoring solution is required on files with 3 or less drawers.</i>			
	<i>5-high.</i>			
	17 3/4 x 28 x 65 1/2	451 x 711 x 1664	RID__-281866VF5	1,560
	14 3/4 x 28 x 65 1/2	375 x 711 x 1664	RID__-281566VF5	1,560

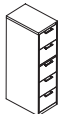

Electronic lock option (D): add \$420.

Counterweight option (W): add \$175.

Specify the pull code (K, M, Z, W). Specify the accent color (A, S).

	<i>4-high.</i>			
	17 3/4 x 28 x 53 3/8	451 x 711 x 1356	RID__-281854VF4	1,250
	14 3/4 x 28 x 53 3/8	375 x 711 x 1356	RID__-281554VF4	1,250

Specify the pull code (K, M, Z, W). Specify the accent color (A, S).

	<i>3-high.</i>			
	17 3/4 x 28 x 40 1/16	451 x 711 x 1018	RID__-281841VF3	1,095
	14 3/4 x 28 x 40 1/16	375 x 711 x 1018	RID__-281541VF3	1,095

Specify the pull code (K, M, Z, W). Specify the accent color (A, S).

	<i>2-high.</i>			
	17 3/4 x 28 x 27 7/8	451 x 711 x 708	RID__-281828VF2	785
	14 3/4 x 28 x 27 7/8	375 x 711 x 708	RID__-281528VF2	785

Specify the pull code (K, M, Z, W). Specify the accent color (A, S).

W x D x H (in)	W x D x H (mm)	Code	Thermofused laminate top (\$)	High-pressure laminate top (\$)
----------------	----------------	------	-------------------------------	---------------------------------

LAMINATE TOPS

Double-faced tape included. When appropriately mounted, back-to-back tops (units with two or more drawers) or side-by-side tops (units with 3 or more drawers) are an efficient alternative to the use of counterweights.

Tops for individual storage unit



<i>Top 1" (25 mm) thick.</i>				
42 1/16 x 18 1/16 x 1	1068 x 458 x 25	R_NNN-T04218	215	290
36 1/16 x 18 1/16 x 1	916 x 458 x 25	R_NNN-T03618	205	265
30 1/16 x 18 1/16 x 1	763 x 458 x 25	R_NNN-T03018	195	255

Specify the finish (1, 2). Smooth edge (N).

<i>Top 1 1/2" (38 mm) thick.</i>				
42 1/16 x 18 1/16 x 1 1/2	1068 x 458 x 38	R_NNN-T04218	290	370
36 1/16 x 18 1/16 x 1 1/2	916 x 458 x 38	R_NNN-T03618	280	330
30 1/16 x 18 1/16 x 1 1/2	763 x 458 x 38	R_NNN-T03018	270	310

Specify the finish (5, 6). Smooth edge (N).

Tops for 2 side-by-side storage units

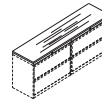

<i>Top 1" (25 mm) thick.</i>				
84 1/8 x 18 1/16 x 1	2136 x 458 x 25	R_NNN-T08418	290	400
72 1/8 x 18 1/16 x 1	1832 x 458 x 25	R_NNN-T07218	265	370
60 1/8 x 18 1/16 x 1	1526 x 458 x 25	R_NNN-T06018	245	340

Specify the finish (1, 2). Smooth edge (N).

<i>Top 1 1/2" (38 mm) thick.</i>				
84 1/8 x 18 1/16 x 1 1/2	2136 x 458 x 38	R_NNN-T08418	400	515
72 1/8 x 18 1/16 x 1 1/2	1832 x 458 x 38	R_NNN-T07218	370	460
60 1/8 x 18 1/16 x 1 1/2	1526 x 458 x 38	R_NNN-T06018	340	430

Specify the finish (5, 6). Smooth edge (N).

Tops for 2 back-to-back storage units.



<i>Top 1" (25 mm) thick.</i>				
42 1/16 x 36 1/8 x 1	1068 x 916 x 25	R_NNN-T04236	265	385
36 1/16 x 36 1/8 x 1	916 x 916 x 25	R_NNN-T03636	255	350
30 1/16 x 36 1/8 x 1	763 x 916 x 25	R_NNN-T03036	235	310

Specify the finish (1, 2). Smooth edge (N).

<i>Top 1 1/2" (38 mm) thick.</i>				
42 1/16 x 36 1/8 x 1 1/2	1068 x 916 x 38	R_NNN-T04236	370	450
36 1/16 x 36 1/8 x 1 1/2	916 x 916 x 38	R_NNN-T03636	360	405
30 1/16 x 36 1/8 x 1 1/2	763 x 916 x 38	R_NNN-T03036	320	370

Specify the finish (5, 6). Smooth edge (N).

Tops for 4 back-to-back storage units

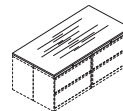

<i>Top 1" (25 mm) thick.</i>				
84 1/8 x 36 1/8 x 1	2136 x 916 x 25	R_NNN-T08436	580	800
72 1/8 x 36 1/8 x 1	1832 x 916 x 25	R_NNN-T07236	530	740
60 1/8 x 36 1/8 x 1	1526 x 916 x 25	R_NNN-T06036	490	680

Specify the finish (1, 2). Smooth edge (N).

<i>Top 1 1/2" (38 mm) thick.</i>				
84 1/8 x 36 1/8 x 1 1/2	2136 x 916 x 38	R_NNN-T08436	800	1,030
72 1/8 x 36 1/8 x 1 1/2	1832 x 916 x 38	R_NNN-T07236	740	920
60 1/8 x 36 1/8 x 1 1/2	1526 x 916 x 38	R_NNN-T06036	680	860

Specify the finish (5, 6). Smooth edge (N).

Tops for individual storage unit - 24" D



<i>Top 1" (25 mm) thick.</i>				
18 1/16 x 24 1/16 x 1	458 x 611 x 25	R_NNN-T01824	170	220
15 1/16 x 24 1/16 x 1	382 x 611 x 25	R_NNN-T01524	160	205

Specify the finish (1, 2). Smooth edge (N).

<i>Top 1 1/2" (38 mm) thick.</i>				
18 1/16 x 24 1/16 x 1 1/2	458 x 611 x 38	R_NNN-T01824	235	280
15 1/16 x 24 1/16 x 1 1/2	382 x 611 x 38	R_NNN-T01524	220	265

Specify the finish (5, 6). Smooth edge (N).

METAL STORAGE FURNITURE

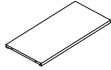
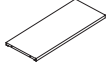
	W x D x H (in)	W x D x H (mm)	Code	Price (\$)
ACCESSORIES				
Additional shelves	<i>Insert into the storage units lateral notches. No tool required.</i>			
	<i>For bookcases.</i>			
	41 ³ / ₄ x 16 ³ / ₄ x ³ / ₄	1060 x 425 x 19	RINNN-TB4218	105
	35 ³ / ₄ x 16 ³ / ₄ x ³ / ₄	908 x 425 x 19	RINNN-TB3618	100
	29 ³ / ₄ x 16 ³ / ₄ x ³ / ₄	756 x 425 x 19	RINNN-TB3018	95
	<i>For cabinets.</i>			
	41 ³ / ₄ x 14 ¹ / ₄ x ³ / ₄	1060 x 362 x 19	RINNN-TA4218	105
	35 ³ / ₄ x 14 ¹ / ₄ x ³ / ₄	908 x 362 x 19	RINNN-TA3618	100
	29 ³ / ₄ x 14 ¹ / ₄ x ³ / ₄	756 x 362 x 19	RINNN-TA3018	95

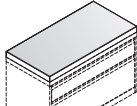
Cushions for low storage units	<i>For 18" D low storage units. Double-faced tape included. Prices are applicable for all Grade 1 United Chair upholstery. For other United Chair® grades, add: Grade 2 : 10%, Grade 3 : 15%.</i>			
	42 x 18 x 2	1067 x 457 x 51	RINNN-CU4218P	455
	36 x 18 x 2	914 x 457 x 51	RINNN-CU3618P	440
	30 x 18 x 2	762 x 457 x 51	RINNN-CU3018P	430

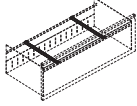

Front-to-back hanging bars for lateral file drawers	<i>2-bar kit. To create 2 letter or legal-size filing rows, 4 bars are needed, except for the 42" wide drawer, which needs 6 bars to create 3 letter-size filing rows. See page 4 for further information about filing capacity.</i>			
	15 ¹ / ₈ x 1 ¹ / ₄ x 1 ¹ / ₄	384 x 32 x 32	LGC-FTB2	38

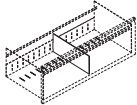

Ganging kit	<i>Allows to attach two storage units back-to-back (2 or more drawers) or side-by-side (3 or more drawers). The mounting kit is an efficient alternative to the use of counterweights. Hole drilling required.</i>			
	RINNN-GKIT			40

Divider for lateral file drawer or low storage unit box drawer	<i>For lateral file or low storage unit utility drawer. Inserts into the drawer slots every 1" (25 mm).</i>			
	18 x ¹ / ₁₆ x 6	457 x 2 x 152	RINNN-DIV6	12

Magnetic dividers for lateral or vertical file	<i>For vertical or lateral file.</i>			
	6 x 15 x 6	152 x 381 x 152	RINNN-DIV186	55
	6 x 12 x 6	152 x 305 x 152	RINNN-DIV156	55
	<i>For utility drawer.</i>			
	2 x 15 x 2	51 x 381 x 51	RINNN-DIV182	45
	2 x 12 x 2	51 x 305 x 51	RINNN-DIV152	45

Compressors	<i>For vertical file. Comes with a grooved drawer bottom and a bracket with a clip.</i>			
	<i>Letter size.</i>			70
	<i>Legal size.</i>			70

	W x D x H (in)	W x D x H (mm)	Code	Price (\$)
Pencil tray for box drawer	<i>Black plastic. Sits on the sides of a 15" W (381 mm) utility drawer and slides for drawer access.</i>			
	<i>Pencil tray for multifunction unit 30" W.</i>			
	12 ¹ / ₈ x 3 x 1	327 x 76 x 25	RINNN-PHU	25
	<i>Metal tray adaptors (pencil tray sold separately).</i>			
	<i>For multifunction unit 36" W</i>			19
	<i>For multifunction unit 42" W</i>			22
Label holders	<i>Insert into the integrated pulls. Clear plastic.</i>			
	<i>For full pull (F)</i>			6
	<i>For recessed aluminum pull (R)</i>			6

Electronic locks	<i>Installation and hole drilling required. For further information, see electronic lock specifications, page 5.</i>			
	<i>For lateral or vertical file (horizontal position).</i>			
	5 ¹ / ₄ x ¹ / ₂ x 1 ¹ / ₄	133 x 13 x 32	RINN_-DHLK	180
	<i>Specify the accent color (A, S).</i>			
	<i>For cabinet or wardrobe (vertical position).</i>			
	1 ¹ / ₄ x ¹ / ₂ x 5 ¹ / ₄	32 x 13 x 133	RINN_-DVUK	180
	<i>Specify the accent color (A, S).</i>			
	<i>Manager Key</i>			85
	<i>Programming Key</i>			125

TERMS & CONDITIONS OF SALE

1. ORDER PLACEMENT

- The seller sells its products in the terms set forth in these standard terms of sale. All orders must be submitted in writing as represented by a valid purchase order, which includes the total list and net dollars. The seller reserves the right to refuse any order.
- The following information is required to process an order.

CUSTOMER INFORMATION	PRODUCT INFORMATION
Sold/Ship to address	Quantity
Purchase order number	Product numbers including options
Authorized signature	Colors and fabrics (all surfaces)
Contact name	Note: Product number overrules the written description and/or comment lines
Consignee contact name and phone	
Bid/Quote # if applicable	
Product total (list/net)	
Preferred delivery date (Specific delivery date not guaranteed)	

Groupe Lacasse Inc. cannot be held responsible for customer's errors, omissions and order duplication due to non-compliance with this procedure.

2. ORDER CHANGES

Any change to an original purchase order must be received in writing no later than 48 hours after receipt of the original order. Any change to the original order after 48 hours, if approved, will result in production rescheduling. The cost variances will have to be approved by the customer before production rescheduling. No changes allowed on QuickShip orders.

3. ORDER CANCELLATIONS

Cancellations must be requested in writing no later than 48 hours after receipt of the original order and are subject to approval by Groupe Lacasse Inc. Cancellations cannot be accepted otherwise. No cancellation allowed on QuickShip orders.

4. ORDER ACKNOWLEDGEMENT

Orders will be acknowledged to dealers by Groupe Lacasse Inc. Please refer to the acknowledgement copy to make sure it agrees with your original purchase order. When corresponding, please refer to the acknowledgement number. If you do not receive your order acknowledgement within 48 hours, please contact our customer service.

5. LIMITED LIFETIME WARRANTY

Groupe Lacasse Inc. warrants its products to be free from defects in material and workmanship for as long as the original purchaser owns it; proof of purchase from Groupe Lacasse Inc. being the only official document accepted by Groupe Lacasse Inc. for any claim. This warranty is subject to the limitations, exclusions and other provisions below:

- Twenty-five years: High-performance thermofused laminate.
- Twenty years: Drawer slides.
- Ten years: Locks.
- Five years: Swing-lift mechanisms and adjustable surface mechanisms.
- Five years: High-pressure laminate, casters, fabrics, metal frame doors, electrical components, thermoplastic polymer extrusions and accessories.
- One year: Electrical modules and electronic locks.
- Exclusions: Light bulbs, ballasts and C.O.M. are not covered by this warranty.

This warranty is made by Groupe Lacasse Inc. only to purchasers acquiring the product directly from Groupe Lacasse Inc., its authorized dealers, or others who are specifically authorized by Groupe Lacasse Inc. to sell such products. Shipping and labour are not covered by the warranty. The purchaser's remedy is limited to repair or replacement, at Groupe Lacasse's option, of products which when used normally, prove to be defective within the period stated. This warranty does not apply to any product which must be replaced because of normal wear and tear, negligence, abuse or accident or which has been modified by someone other than Groupe Lacasse Inc. or its authorized dealers. The remedy stated herein are expressly agreed to be exclusive as a condition of sale. Groupe Lacasse Inc.'s liability with respect to its products or installation services should not exceed that expressly set forth above. Under no circumstances shall Groupe Lacasse Inc. be liable for accidental or consequential damages. Specials may be subject to a limited warranty.

6. PRICES

All prices listed are suggested retail prices, F.O.B. our factory, St-Pie, Quebec, Canada. Accepted orders are subject to prices and taxes prevailing at the time of shipment. Prices and taxes are subject to change without notice. If shipping date requested is more than 90 days from date of order, Groupe Lacasse Inc. shall have the right to use the published list prices effective at the time of shipment. Prices shown in price book have priority over electronic catalog contents.

7. TERMS (UPON ACCEPTANCE FROM OUR CREDIT DEPARTMENT)

Net 30 days from date of invoice. Any product sold shall remain the property of Groupe Lacasse Inc. and shall remain the seller's property until paid for. The buyer agrees to perform all acts which may be necessary to protect and assure retention of title to such products by Groupe Lacasse Inc. until such time as goods have been paid for in full. No sales within a one-year period will automatically lead to the account's closure.

8. QUOTATIONS

Quotations are valid for a period of ninety (90) days unless otherwise specified on the quote.

9. CHANGES

All illustrations, specifications and prices in this book are based on the latest product information available at the time of publication. The right is reserved to make changes, at any time and without prior notice, to prices, colors, materials, specifications and models offered.

10. PACKING AND SHIPPING

Packaging consists of polyethylene and protectors or separate cartons, depending on method of shipment.

11. DELIVERY

The scheduled delivery week is specified on our acknowledgment. Groupe Lacasse is not liable for delay or failure to deliver goods due to causes beyond its control (such as a casualty, an act of god, a labor dispute, or an accident;

the inability to obtain the necessary labor, material or transportation; or any change requested by the customer). Under these circumstances, the ship date will be extended to compensate for the delay as determined by the Seller.

Groupe Lacasse will accept, upon prior approval by Logistics and Customer Service departments, to make installation job site deliveries for a minimum of one half of a full truckload (1,200 cubic feet / 33.98 m³); however, and in all cases, an unloading dock must be available to accommodate 53 ft. / 16.15 m trailers and the address is also subject to approval. Unloading at destination is the sole responsibility of the purchaser. No waiting time will be possible; however, and if any is incurred, it will be recharged to the purchaser.

Under no circumstance will Groupe Lacasse deliver goods in a residential area.

Surcharge

Time sensitive deliveries (weekend deliveries, night, etc.) that require expedited carrier service will result in additional charges that will be passed onto the consignee (dealer). Liftgates: Our standard carriers do not have liftgates. Requests for liftgates can often be accommodated but will result in extra fees and they must be made at least 2 weeks in advance.

12. SHIPPING WEIGHTS AND VOLUMES

Shipping weights and volumes are available on the Groupe Lacasse website and may vary due to the constantly improving methods of packaging.

13. ROUTING

Unless otherwise specified by the buyer and agreed to by Groupe Lacasse, the latter reserves the right to select the route, method of shipment and carrier. Customer requests for special carrier, method of shipment and/or routing will be shipped freight collect.

14. TRANSPORTATION POLICY

"Zone 0" shipments are FCA plant. "Zone 1", "Zone 2", "Zone 3", "Zone 4" and "Zone 5" pricing includes freight cost to your geographical location.

On all orders less than \$2,000 net (regardless of brand and/or of shipping point) we will add a \$100 "small order fee".

Please take note of the following exclusion to the "small order fee":

- By combining different product collections in one order, even if the net value of each collection is less than \$2,000 net, but the total value of all collections in one order is at least or above \$2,000 net, and as long as all products are shipped at the same destination / receiving location (ship to), the fee will not apply regardless of shipping dates and points of origins.

Small orders under \$25 net are subject to a \$20 small order fee (instead of \$100) regardless of the shipping zones.

Freight charges beyond the continental United States are the purchaser's responsibility. Shipments beyond the continental United States must deliver to a freight forwarder or forwarding carrier of your choice. It is the customer's responsibility to provide this information on purchase orders.

15. FREIGHT CLAIMS

All FCA destination claims will be handled and filed by the Seller. In order to expedite any credit due, your help and assistance is required. Please adhere to the following guidelines:

The merchandise is carefully packed and thoroughly inspected before leaving the warehouse. Responsibility for its safe delivery is assumed by the carrier upon acceptance of the shipment. Claims for loss or damage sustained in transit must therefore be made to Groupe Lacasse as follows:

1) Concealed loss or damage

Concealed loss or damage means loss or damage that does not become apparent until the merchandise has been unpacked. The contents may be damaged in transit due to rough handling even though the carton may not show external damage. When damage is discovered upon unpacking, a written request within 15 days of the delivery date must be made. No disposition will be taken until approved from the manufacturer.

IMPORTANT: Groupe Lacasse's policy in concealed damage is to replace the part or complete product if necessary at no charge to the dealer. However, it is the responsibility of the dealer to provide installation of the replaced part or complete product. Therefore, no labor fees will be accepted on concealed damages.

2) Visible damage or shortage

Any external evidence of damage or shortage must be noted on the freight bill or express receipts and signed by the carrier's agent. Failure to adequately describe such external evidence of damage or shortage may result in refusing to honor a damage claim. Claims must be submitted within 5 business days of reception of the merchandise.

Submit your claim to the Groupe Lacasse Customer Service by email at: lacassecustomer.service@groupe-lacasse.com.

Phone: 1-888-522-2773 - Fax: 1-888-248-1865

16. RETURNS

Absolutely no returns will be accepted on any standard and non-standard products.

17. STORAGE

In the event the purchaser requests the postponement of a shipment beyond the scheduled shipping week after the goods have become work in process, or are ready to be shipped, Groupe Lacasse can make arrangements to store the goods but at the purchaser's risk and expense. Such transfer to storage shall be deemed delivery to purchaser for all purposes including invoicing and payment.

18. GOVERNING LAW

This contract shall be construed and governed in accordance with the laws of the province of Quebec, Canada.

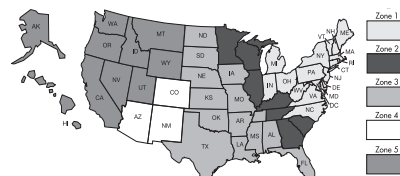

Metal Storage Furniture > Price Book > USA > March 2017

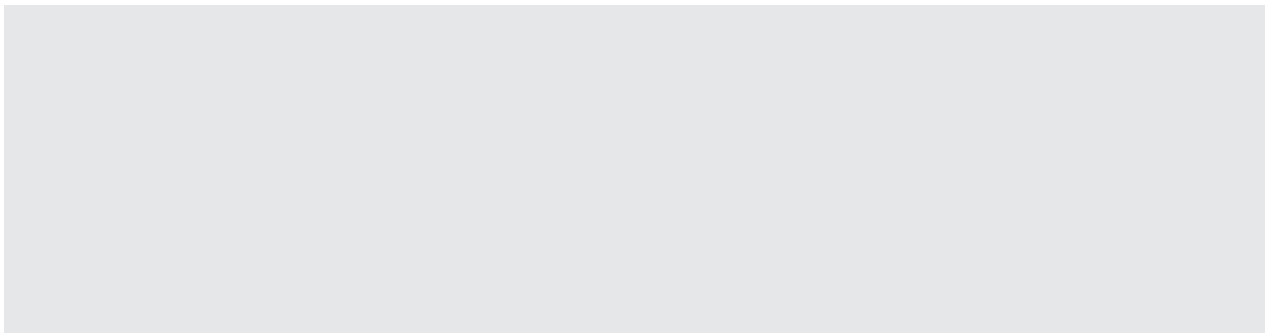

Office Furniture Solutions

Founded in 1956, Groupe Lacasse is a North American leader in the design, manufacture and service of a broad range of high-quality furniture products for all types of work environments. We have the experience, expertise and capability to deliver incomparable design, exceptional quality, optimum service and outstanding value in Office Furniture Solutions.



1-888-522-2773
www.groupelacasse.com



Groupe Lacasse has achieved GREENGUARD GOLD Certification.
GREENGUARD Certified products are certified to GREENGUARD standards for low chemical emissions into indoor air during product usage. For more information, visit ul.com/gg.